



Фитинги с накидной гайкой. Присоединения М5 - G1/2". Трубки от 4 мм до 15 мм.



Фитинги с накидной гайкой

Данные фитинги предназначены для присоединения пластиковых трубок к пневмоаппаратуре. Фиксация и уплотнение трубки обеспечивается путем её зажима между коническими поверхностями фитинга и гайки. Такое соединение хорошо противостоит вибрациям и загрязнениям в окружающей среде. Фитинги выполнены из никелированной латуни. Для данной серии фитингов важно чтобы внешний и внутренний диаметр трубки соответствовали указанным в таблице через дробь. Например трубка 8/6 означает, что наружный диаметр трубки должен быть 8 мм, а внутренний - 6 мм. Рабочая температура определяется допустимой температурой для присоединенных трубок. Максимально допустимое давление определяется типом трубки (смотри раздел "трубки пневматические").

Расшифровку условных обозначений в таблицах смотрите на стр. 6-01/1.

Артикул 301

Фитинг прямой с конической резьбой

Никелированная латунь

Код	ØD	F	I	H			
3010418	4/2,5	R1/8"	8,0	25,5	9	12	100
3010518	5/3	R1/8"	8,0	25,0	8	12	100
3010618	6/4	R1/8"	8,0	26,5	12	12	100
3010614	6/4	R1/4"	11,0	30,0	12	14	100
3010638	6/4	R3/8"	11,5	30,5	12	17	100
3010818	8/6	R1/8"	8,0	26,5	14	12	100
3010814	8/6	R1/4"	11,0	30,0	14	14	100
3010838	8/6	R3/8"	11,5	30,5	14	17	100
3010812	8/6	R1/2"	14,0	33,5	14	22	50
3011018	10/8	R1/8"	8,0	29,0	16	14	50
3011014	10/8	R1/4"	11,0	32,0	16	14	50
3011038	10/8	R3/8"	11,5	32,5	16	17	50
3011012	10/8	R1/2"	14,0	35,5	16	22	50
3011238	12/10	R3/8"	11,5	35,5	18	17	50
3011212	12/10	R1/2"	14,0	38,5	18	22	50
3011512	15/12	R1/2"	14,0	40,0	22	22	25

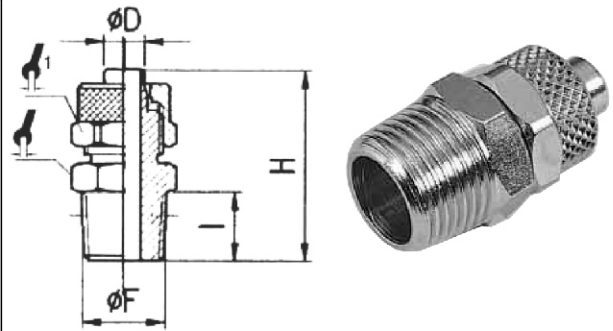

Артикул 301z

Фитинг прямой с цилиндрической резьбой

Никелированная латунь

Код	ØD	F	I	H			
301Z04M5	4/2,5	M5	4,0	20,0	8	9	100
301Z0418	4/2,5	G1/8"	6,0	21,5	8	13	100
301Z05M5	5/3	M5	4,0	20,0	8	8	100
301Z05M6	5/3	M6	4,0	22,1	8	8	100
301Z0518	5/3	G1/8"	6,0	24,1	8	13	100
301Z06M5	6/4	M5	3,8	21,8	8	8	100
301Z0618	6/4	G1/8"	6,0	24,5	12	13	100
301Z0614	6/4	G1/4"	8,0	27,0	12	17	100
301Z0638	6/4	G3/8"	9,0	28,0	12	19	50
301Z0818	8/6	G1/8"	6,0	24,5	14	14	100
301Z0814	8/6	G1/4"	8,0	27,0	14	17	50
301Z0838	8/6	G3/8"	9,0	28,0	14	19	50
301Z1014	10/8	G1/4"	8,0	29,0	16	17	50
301Z1038	10/8	G3/8"	9,0	30,0	16	19	25
301Z1238	12/10	G3/8"	9,0	33,0	18	19	25
301Z1212	12/10	G1/2"	10,0	35,0	18	24	25
301Z1512	15/12	G1/2"	10,0	35,0	22	24	25

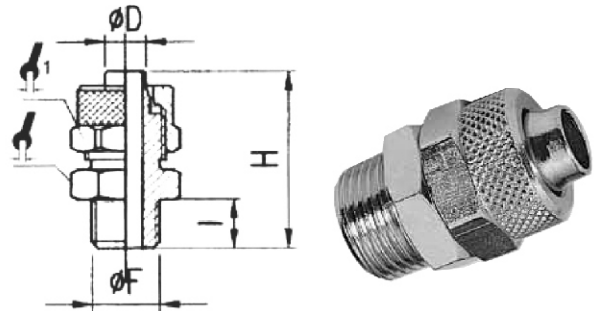

Артикул 302

Фитинг прямой с внутренней цилиндрической резьбой

Никелированная латунь

Код	ØD	F	I	H			
3020618	6/4	G1/8"	6,5	25,5	12	14	100
3020614	6/4	G1/4"	8,0	27,5	12	17	100
3020638	6/4	G3/8"	10,0	31,0	12	22	50
3020818	8/6	G1/8"	6,5	25,5	14	14	100
3020814	8/6	G1/4"	8,0	27,5	14	17	100
3020838	8/6	G3/8"	10,0	31,0	14	22	50
3021014	10/8	G1/4"	8,0	29,5	16	17	50
3021038	10/8	G3/8"	10,0	33,0	16	22	50
3021238	12/10	G3/8"	10,0	36,0	18	22	50

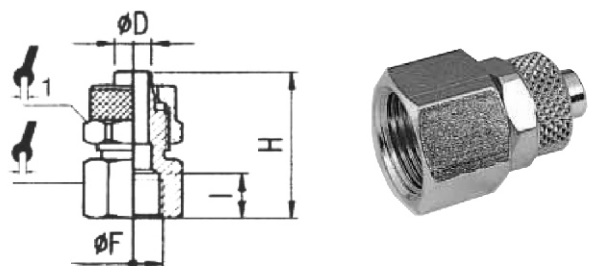



Фитинги с накидной гайкой.
Присоединения М5 - G1/2". Трубки от 4 мм до 15 мм.



Артикул 303

Фитинг-соединитель

Никелированная латунь

Код	ØD	L						
3030500	5/3	28,5				8	8	100
3030600	6/4	32,0				12	12	100
3030800	8/6	32,0				14	12	10
3031000	10/8	37,0				16	14	50
3031200	12/10	43,0				18	17	50
3031500	15/12	46,5				22	22	25

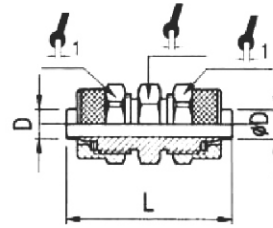

Артикул 304

Фитинг-соединитель с монтажными гайками

Никелированная латунь

Код	ØD	A	L					
3040600	6/4	M10x1	45,0			12,0	14,0	100
3040800	8/6	M12x1	48,0			14,0	17,0	50
304100	10/8	M14x1	54,0			16,0	17,0	50
3041200	12/10	M16x1	57,0			18,0	19,0	25
3041500	15/12	M20x1	59,0			22,0	24,0	25

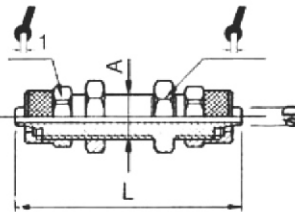

Артикул 305

Фитинг угловой с конической резьбой

Никелированная латунь

Код	ØD	F	I	H	L				
3050518	5/3	R1/8"	8,0	17,0	21,5		8	8	100
3050618	6/4	R1/8"	8,5	17,0	20,5		12	8	100
3050614	6/4	R1/4"	12,5	21,0	20,5		12	8	100
3050638	6/4	R3/8"	15,5	23,0	20,5		12	8	50
3050818	8/6	R1/8"	8,0	17,0	20,5		14	10	100
3050814	8/6	R1/4"	12,5	21,5	20,5		14	10	100
3050838	8/6	R3/8"	15,3	23,8	20,5		14	10	50
3051018	10/8	R1/8"	8,0	17,0	24,5		16	12	50
3051014	10/8	R1/4"	12,5	22,0	24,5		16	12	50
3051038	10/8	R3/8"	14,8	24,3	24,5		16	12	50
3051012	10/8	R1/2"	14,0	28,0	28,0		16	17	25
3051238	12/10	R3/8"	14,0	26,0	29,0		18	14	50
3051212	12/10	R1/2"	16,0	28,0	29,0		18	14	25
3051512	15/12	R1/2"	15,0	28,0	24,0		22	16	25

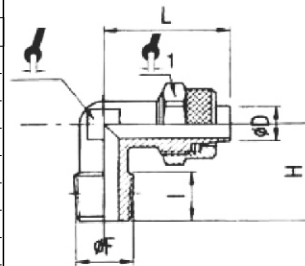

Артикул 305F

Фитинг угловой с внутренней цилиндрической резьбой

Никелированная латунь

Код	ØD	F	I	H	L				
305F0618	6/4	G1/8"	7,0	20,5	20,5		12	8	100
305F0614	6/4	G1/4"	8,0	22,5	20,5		12	8	50
305F0818	8/6	G1/8"	7,0	20,5	20,5		14	10	100
305F0814	8/6	G1/4"	8,0	23,5	20,5		14	10	50
305F1014	10/8	G1/4"	8,0	24,0	24,5		16	12	50
305F1038	10/8	G3/8"	10,0	27,0	24,5		16	12	25
305F1238	12/10	G3/8"	10,0	29,0	29,0		18	14	25

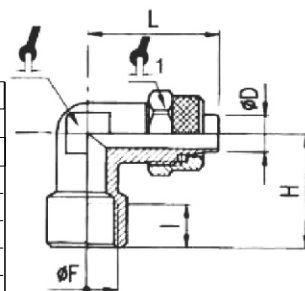

6

Артикул 306

Фитинг-соединитель угловой

Никелированная латунь

Код	ØD	L						
3060600	6/4	20,5				12	8	100
3060800	8/6	20,5				14	10	100
3061000	10/8	24,5				16	12	50
3061200	12/10	29,0				18	14	25
3061500	15/12	34,0				22	16	25

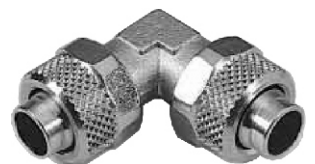
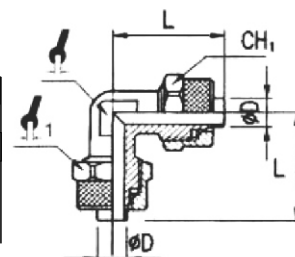

6



Фитинги с накидной гайкой.
Присоединения М5 - G1/2". Трубки от 4 мм до 15 мм.



Артикул 307

Фитинг-тройник с конической резьбой, тип "Т"

Никелированная латунь

Код	ØD	F	I	H	L				
3070618	6/4	R1/8"	8,5	17,0	41,0		12	8	100
3070614	6/4	R1/4"	13,0	21,5	41,0		12	8	50
3070818	8/6	R1/8"	8,0	16,5	41,0		14	10	50
3070814	8/6	R1/4"	12,5	21,0	41,0		14	10	50
3070838	8/6	R3/8"	15,3	23,8	41,0		14	10	50
3071018	10/8	R1/8"	8,0	18,5	49,0		16	12	50
3071014	10/8	R1/4"	11,8	22,3	49,0		16	12	50
3071038	10/8	R3/8"	14,7	25,2	49,0		16	12	25
3071238	12/10	R3/8"	14,1	26,0	58,0		18	14	25
3071212	12/10	R1/2"	15,0	27,0	58,0		18	14	25
3071512	15/12	R1/2"	14,4	27,4	68,0		22	16	10

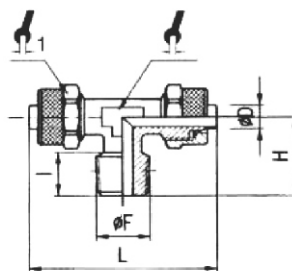

Артикул 308

Фитинг-тройник с конической резьбой, тип "L"

Никелированная латунь

Код	ØD	F	I	L	H				
3080618	6/4	R1/8"	8,5	20,5	37,5		12	8	100
3080614	6/4	R1/4"	13,0	20,5	42,0		12	8	50
3080818	8/6	R1/8"	8,0	20,5	37,0		14	10	50
3080814	8/6	R1/4"	12,5	20,5	41,5		14	10	50
3080838	8/6	R3/8"	13,3	20,5	44,3		14	10	50
3081018	10/8	R1/8"	8,0	25,5	44,0		16	12	50
3081014	10/8	R1/4"	11,8	24,5	46,8		16	12	50
3081038	10/8	R3/8"	14,7	24,5	49,7		16	12	25
3081238	12/10	R3/8"	14,1	29,0	55,1		18	14	25
3081212	12/10	R1/2"	15,0	29,0	56,0		18	14	20
3081512	15/12	R1/2"	14,4	34,0	61,4		22	16	10

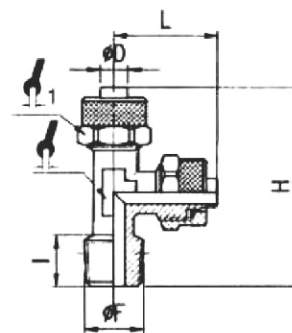

Артикул 309

Тройник

Никелированная латунь

Код	ØD	H	L						
3090600	6/4	20,5	41,0				12	8	50
3090800	8/6	20,5	41,0				14	10	50
3091000	10/8	24,5	49,0				16	12	25
3091200	12/10	29,0	58,0				18	14	25
3091500	15/12	34,0	68,0				22	16	10

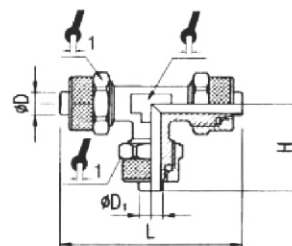

Артикул 310

Гайка

Никелированная латунь

Код	ØD	F	H					
3100400	4/2,5	M7x0,75	10,0				7	100
3100500	5/3	M7x0,75	10,0				8	100
3100608	6/4	M8x0,75	11,0				8	100
3100610	6/4	M10x1	11,0				12	100
3100800	8/6	M12x1	11,5				14	100
3101000	10/8	M14x1	13,5				16	100
3101200	12/10	M16x1	15,0				18	100
3101500	15/12	M20x1	14,5				22	50

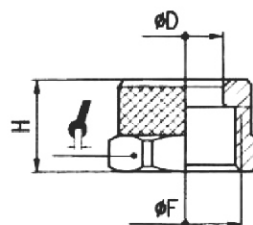

6

Артикул 311

Четвертник

Никелированная латунь

Код	ØD	L							
3110600	6/4	41,0					12	8	50
3110800	8/6	41,0					14	10	50
3111000	10/8	49,0					16	12	25
3111200	12/10	58,0					18	14	20

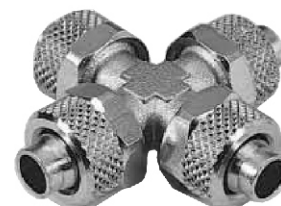
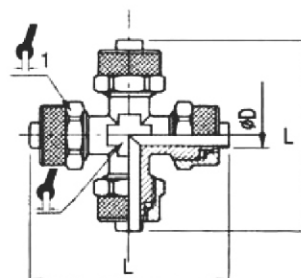

6



Фитинги с накидной гайкой.
Присоединения М5 - G1/2". Трубки от 4 мм до 15 мм.



Артикул 405

Фитинг-серьга под пустотелый винт

Никелированная латунь

Совместим с винтами 407, 408, 33А, 34А
и дросселями 28А, 29А, 30А

Код	ØD	G	H	L			
40504M5	4/2,5	M5	9,0	16,5			9 100
40506M5	6/4	M5	9,0	18,0			9 100
4050618	6/4	G1/8"	15,0	23,5			12 100
4050614	6/4	G1/4"	17,0	25,5			12 100
4050818	8/6	G1/8"	15,0	22,5			14 100
4050814	8/6	G1/4"	17,0	24,5			14 50
4050838	8/6	G3/8"	20,0	26,0			14 50
4051014	10/8	G1/4"	17,0	25,5			16 50
4051038	10/8	G3/8"	14,5	27,0			16 50
4051238	12/10	G3/8"	20,0	29,5			18 25

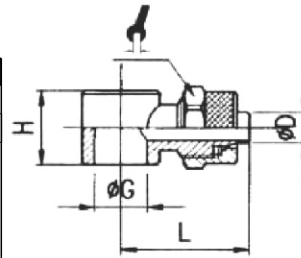

Артикул 406

Фитинг-серьга двухсторонняя под пустотелый винт

Никелированная латунь

Совместим с винтами 407, 408, 33А, 34А
и дросселями 28А, 29А, 30А

Код	ØD	G	H	L			
40604M5L*	4/2,5	M5	12,5	42,0			7 100
40606M5L*	6/4	M5	12,5	42,0			8 100
4060618	6/4	G1/8"	15,0	47,0			12 100
4060614	6/4	G1/4"	14,5	51,0			12 50
4060818	8/6	G1/8"	15,0	45,0			14 50
4060814	8/6	G1/4"	14,5	49,0			14 50
4060838	8/6	G3/8"	20,0	52,0			14 25
4061014	10/8	G1/4"	14,5	51,0			16 50

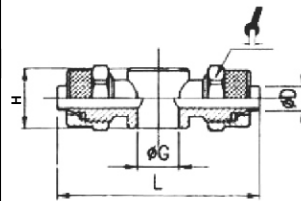

* Данные фитинги совместимы только с винтами 407M5L

Артикул 412

Фитинг-серьга под пустотелый винт

Никелированная латунь

Совместим с винтами 407, 408, 33А, 34А
и дросселями 28А, 29А, 30А

Код	ØA	ØB	ØC	D	H		
41218	G1/8"	G1/8"	14	20,0	15,0		50
41214	G1/4"	G1/4"	18	24,0	17,0		50
41238	G3/8"	G3/8"	21	28,5	20,0		25
41212	G1/2"	G1/2"	26	34,5	24,0		25

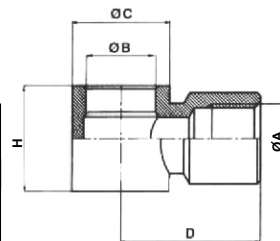

Артикул 411

Прокладка уплотнительная

арт. 411 - алюминий

арт. 411P - нейлон

Код	A	B	D	H			
411PM5	M5	9,0	5,1	1,5			100
411P18	G1/8"	14,0	9,8	1,5			100
411P14	G1/4"	18,0	13,5	1,5			100
411P38	G3/8"	22,0	17,0	1,5			100
411P12	G1/2"	27,0	21,5	1,5			100
411M5	M5	8,8	5,2	1,0			100
41118	G1/8"	13,8	9,8	1,5			100
41114	G1/4"	18,0	13,2	1,5			100
41138	G3/8"	21,0	16,8	1,5			100
41112	G1/2"	26,0	20,8	1,5			100
41134	G3/4"	32,8	26,8	1,5			100

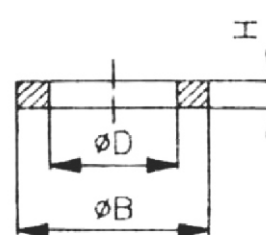



Фитинги с накидной гайкой.
Присоединения М5 - G1/2". Трубки от 4 мм до 15 мм.



Артикул 407

Пустотельный винт с уплотнительными кольцами
Никелированная латунь (кольца - пербунан (NBR))

Код	A	B	C	L			
40718	G1/8"	4,5	13,8	25,0		14	100
40714	G1/4"	6,0	16,7	30,0		17	50

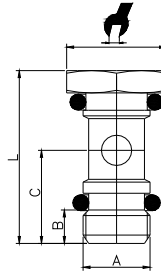

Артикул 407V

Пустотельный винт
Никелированная латунь
Используется совместно с прокладками арт. 411, 411P

Код	A	B	C	L			
407M5	M5	5,8	9,6	17,5		8	100
407M5L*	M5	5,8	12,0	22,0		8	100
40718V	G1/8"	9,0	15,0	28,0		14	100
40714V	G1/4"	11,0	18,0	33,0		17	50
40738	G3/8"	12,0	21,5	37,0		22	50
40712	G1/2"	14,0	24,0	42,0		27	25

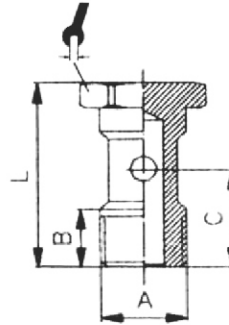

* Винт поставляется в комплекте с 2-мя прокладками

Артикул 408

Пустотельный 2-х уровневый винт с уплотнительными кольцами
Никелированная латунь (кольца - пербунан (NBR))

Код	A	B	C	D	L		
40818	G1/8"	4,5	13,8	29,0	40,0	14	50
40814	G1/4"	6,0	16,7	33,5	47,0	17	50

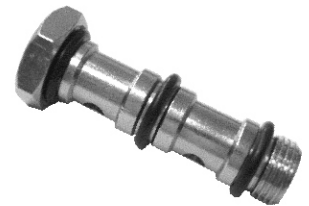
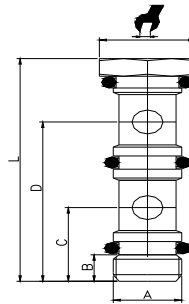

Артикул 408V

Пустотельный винт
Никелированная латунь
Используется совместно с прокладками арт. 411, 411P

Код	A	B	C	D	L		
40818V	G1/8"	9,0	15,0	31,0	44,5	14	50
40814V	G1/4"	11,0	17,0	36,0	51,5	17	50
40838	G3/8"	12,0	20,5	42,0	58,6	22	25
40812	G1/2"	14,0	24,0	50,0	68,0	27	20

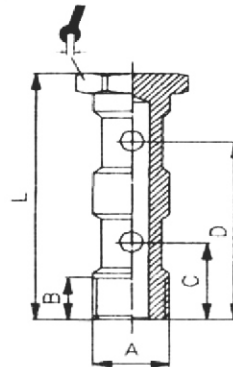

6

Артикул 409

Пустотельный проходной винт с уплотнительными кольцами
Никелированная латунь (кольца - пербунан (NBR))

Код	G	F	L	L1	A		
40918	G1/8"	G1/8"	32,0	13,3	7,0	14	50
40914	G1/4"	G1/4"	38,0	15,2	9,3	17	50

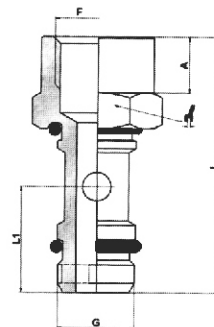

6